

**Compliance Approved**  
**Bluetooth 4.0 Low Energy BLE RF Module**  
**With Built-In ARM Cortex M0 Microcontroller**

**RFD22301**

<p><b>CE, ETSI, IC, FCC Approved</b></p> 	<p>Easy to solder 0.050 Inch SMT pads</p>  <p>15mm x 15mm (0.600 x 0.600 Inch)</p>
--	--

**RFD22302**

Optional Configuration



**CE • ETSI**

Requires Ext. Ant  
External Antenna

**CE, ETSI, IC, FCC  
Approved & Certified**

Hi performance, professional grade Bluetooth 4.0 Low Energy radio transceiver with built-in ARM Cortex M0 microcontroller that can be programmed using the simple-to-use Arduino IDE using RFduino extensions.

Built-in user application microcontroller with ADC, I2C, SPI, UART and GPIO.

Can wirelessly communicate with with iOS iPhone, iPad or Android smartphones or tables.

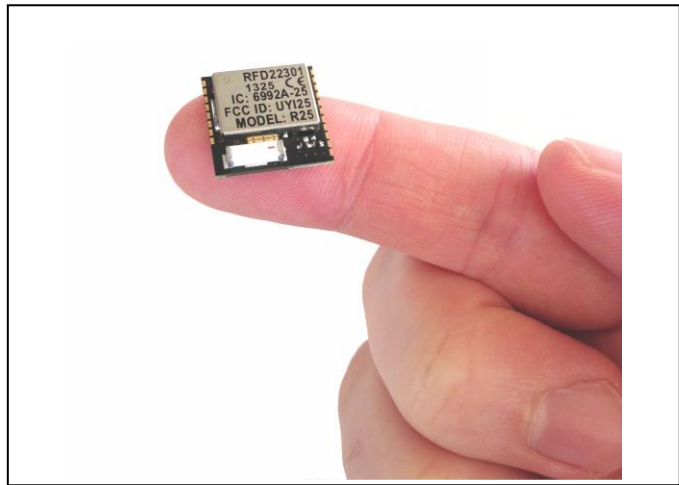

**TYPICAL APPLICATIONS**

<ul style="list-style-type: none"> <li>• Active RFID</li> <li>• Long Range RFID</li> <li>• Remote Control</li> <li>• Light Controls</li> <li>• Home Automation</li> <li>• Alarm Security</li> <li>• Keyless Entry</li> <li>• Perimeter Monitoring</li> </ul>	<ul style="list-style-type: none"> <li>• PC Keyboard Security</li> <li>• Wireless Keyboard</li> <li>• Wireless Mouse</li> <li>• TV Remote</li> <li>• Home Stereo Remote</li> <li>• Asset Tracking</li> <li>• Wireless PTT</li> <li>• Remote Switches</li> </ul>	<ul style="list-style-type: none"> <li>• Remote Terminals</li> <li>• Wireless RS232 DB9</li> <li>• Wireless RS485</li> <li>• Temperature Control</li> <li>• HV/AC</li> <li>• Meter Reading</li> <li>• Data Acquisition</li> <li>• Inventory Control</li> </ul>	<ul style="list-style-type: none"> <li>• Keyfob Remotes</li> <li>• Industrial Controls</li> <li>• Vending Machines</li> <li>• Pan-Tilt-Zoom Control</li> <li>• Camera Flash Control</li> <li>• Biometrics</li> <li>• Seismic Monitoring</li> <li>• M2M &amp; many more...</li> </ul>
--	---	--	--

**RFD22301 Pinout - Top View**

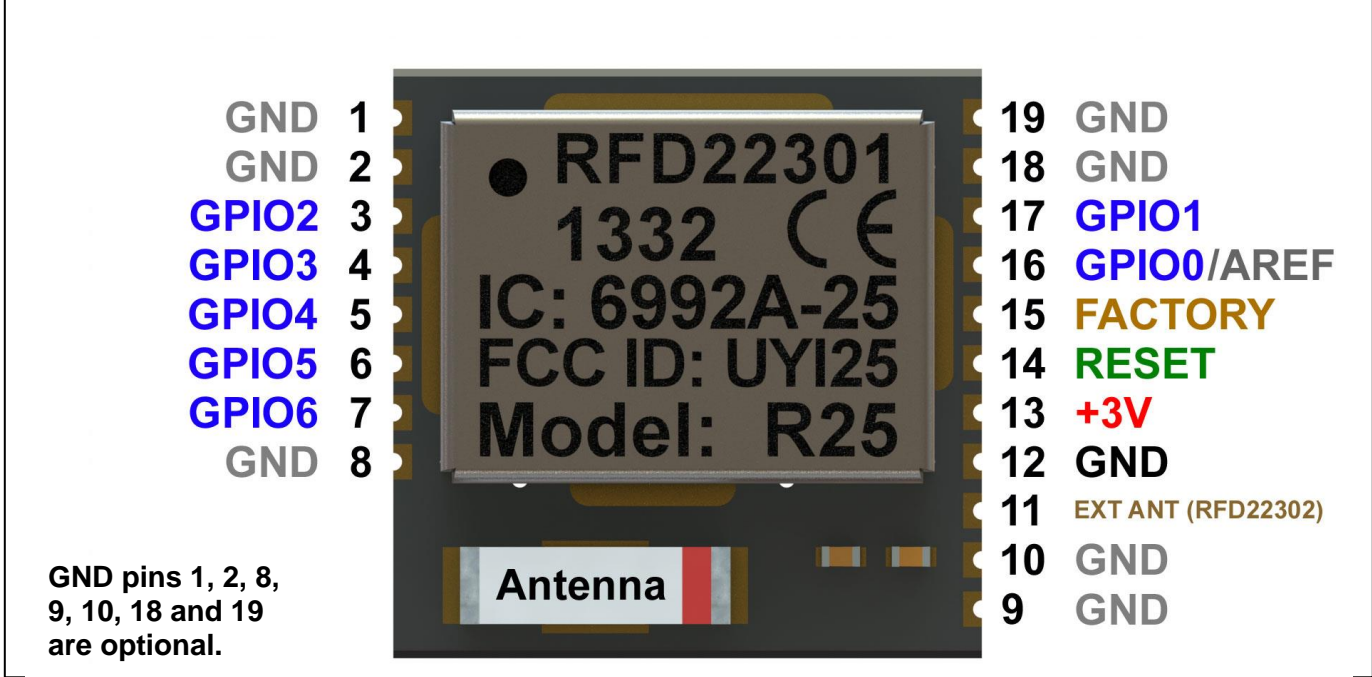

**RFD22301 Pinout - Bottom View**

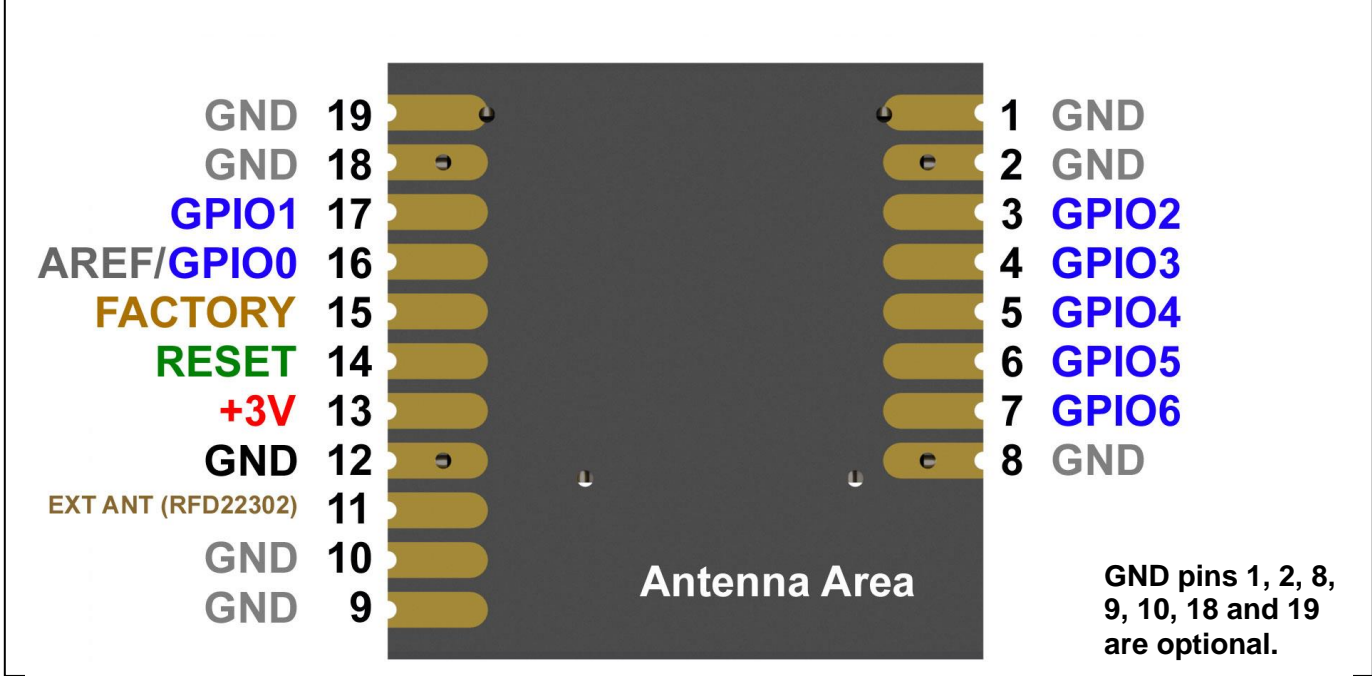

## Electrical Specifications

Description	Min	Nom	Max	Notes
VDD - Supply Voltage	2.1 V	3.0 V	3.6 V	
ESD - Human Body Model Class 2			4 kV	
Built-in Crystal Frequency		16 MHz		
Crystal Frequency Tolerance			+/- 10ppm	
Built-in RC Oscillator Frequency		32.768 kHz		
Built-in RC Oscillator Tolerance		+/- 2%		
Built-in RC Oscillator Tolerance after calibration			250 ppm	
Reset pin time for successful reset	600 ns			
Radio Operating Frequencies	2402 MHz		2481 MHz	1 MHz channel spacing
Radio Frequency Deviation @ BLE	+/- 225 kHz	+/- 250 kHz	+/- 275 kHz	
Radio On-Air data rate	250 kbps		2000 kbps	
Radio Output Power	-30 dBm		+4 dBm	
Receiver Sensitivity @ BLE		-93 dBm		Ideal transmitter
Radio RSSI Accuracy			+/- 6 dB	
UART Baud Rate	1.2 kbps		921.6 kbps	
SPI Bit Rate	0.125 Mbps		8 Mbps	
TWI Bit Rate	100 kbps		400 kbps	
Analog-to-Digital Converter (ADC) ENIB	10 bit			
ADC Internal Reference Voltage	1.182 V	1.20 V	1.218 V	
ADC External Reference Voltage	0.83 V	1.20 V	1.30 V	
Internal Temperature Sensor Range	-25 °C		75 °C	
Internal Temperature Sensor Accuracy	-4 °C		4° C	
General Purpose I/O (GPIO) input high voltage	0.7 * VDD		VDD	
General Purpose I/O (GPIO) input low voltage	VSS		0.3 * VDD	
Output standard drive current		0.5 mA		
Output high drive current		5 mA		Max 3 pins
Pull-up resistance	11k	13k	16k	
Pull-down resistance	11k	13k	16k	
ULP Current with RC OSC Running		4uA		
Transmit Current		12mA		
Receive Current		12mA		
ARM CPU Running Current		4mA		

## RFD22301 IDE & Programming Tools

The RFD22301 can be programmed using different IDEs, however we recommend using the Arduino based RFduino IDE. Download RFduino Quick Start Guide: <http://forum.rfduino.com/index.php?topic=14.0> Or go to <http://RFduino.com/> and click on **Forum**.

Using the free Arduino IDE with RFduino extensions, you can instantly load different pre-written examples and be up and running with your applications quickly and easily.

Open Source iOS sample apps for iPhone and iPad are available in the Apple App Store In the <http://www.RFduino.com> there is already an Android sample app published, it is the first of many others to follow which are contributed by the RFduino community.

Download RFduino library: <https://github.com/RFduino/RFduino>  
Or go to <http://RFduino.com> and click on **Download**.

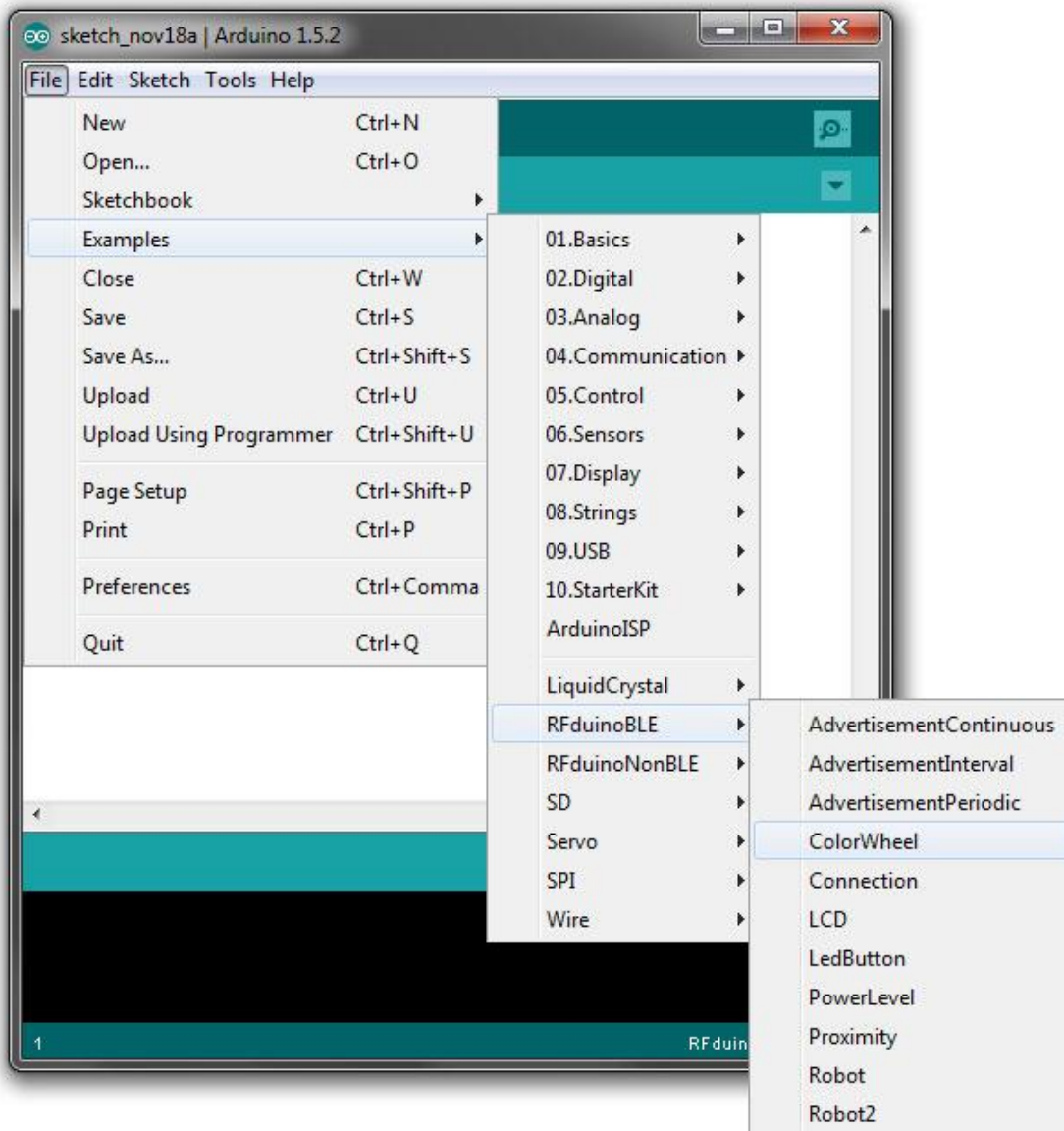

**RFD22301 Programming Interface**

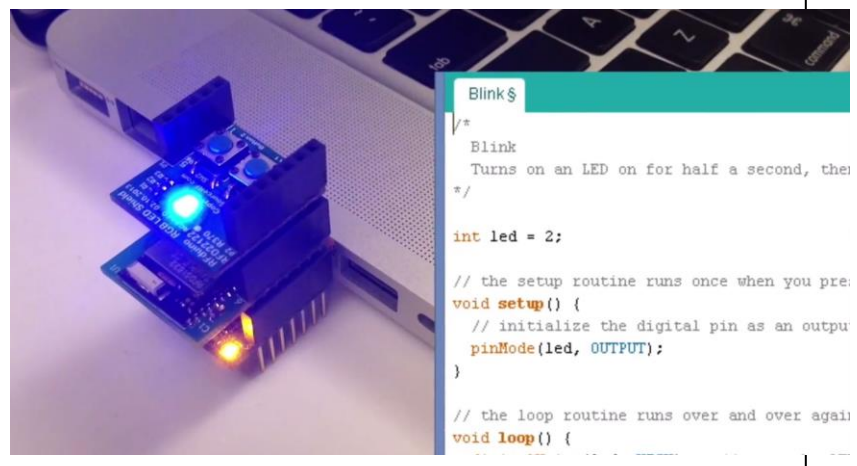
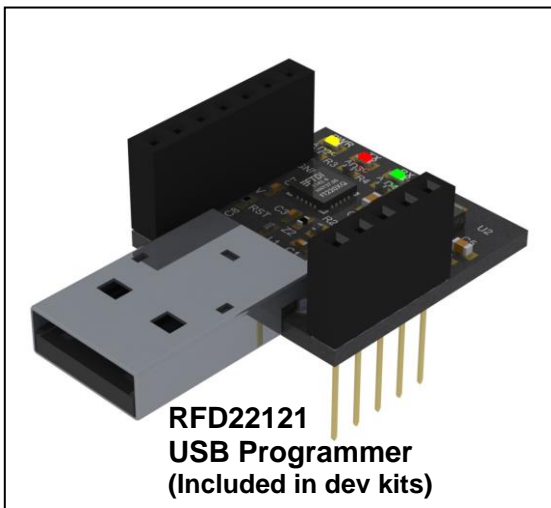
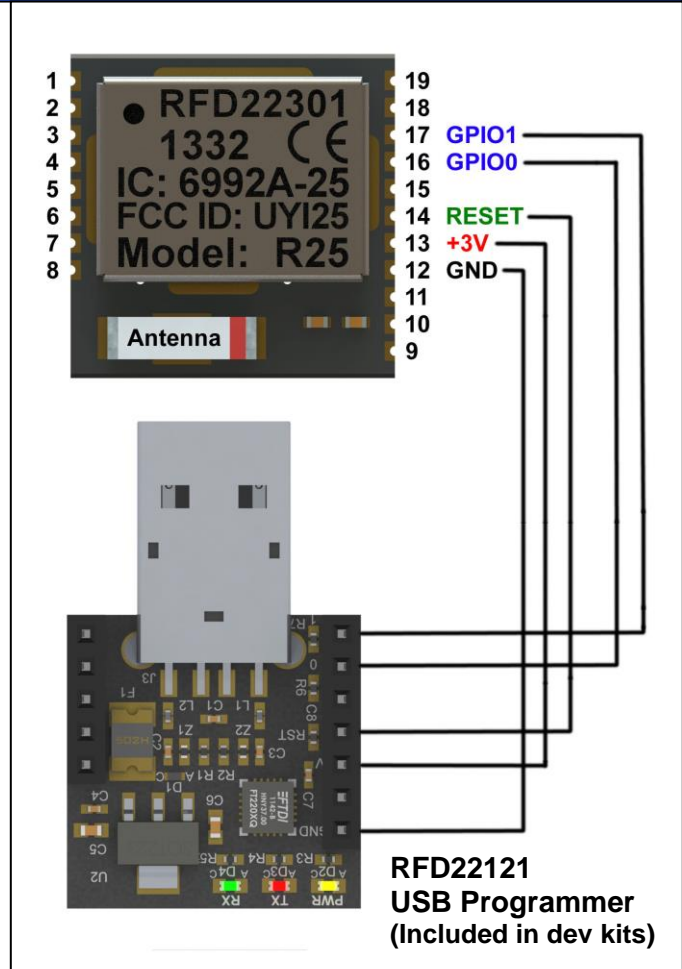
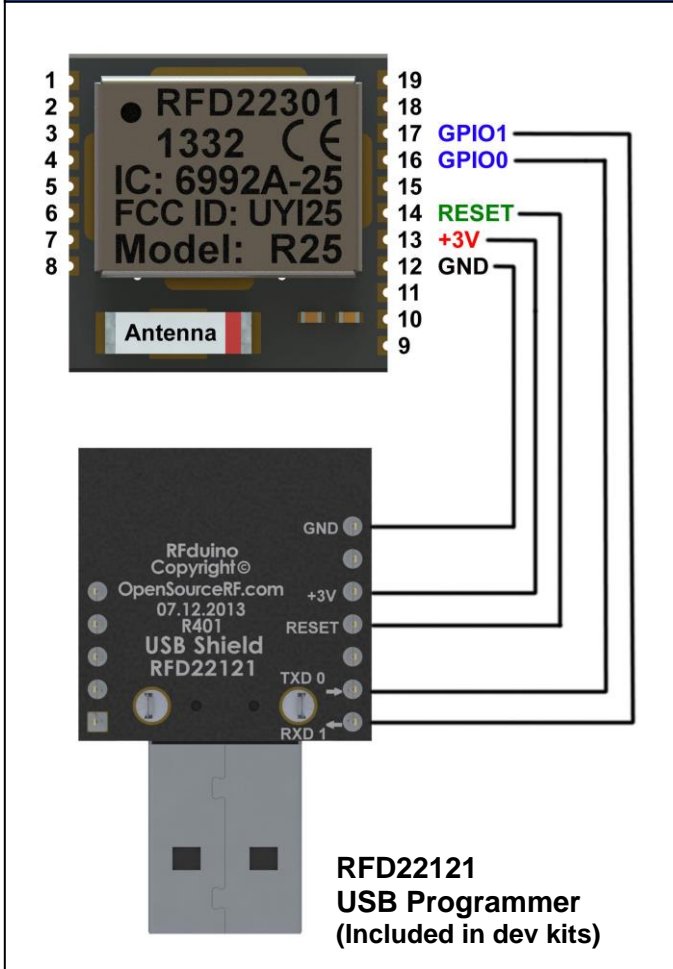

**RFD22301 Rapid Development & Prototyping Kits**

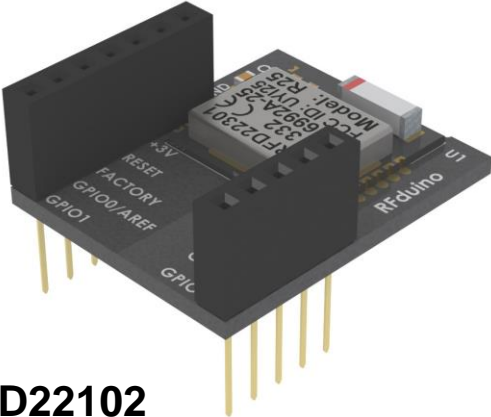

**RFD22102**

DIP version of RFD22301 for prototyping

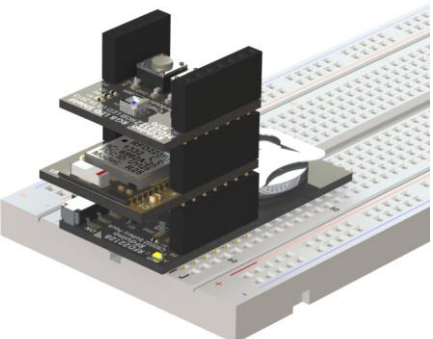

Stackable accessories plug into breadboards

**RFduino**  
 Rapid Development & Prototyping

Based on RFD22301 RF Module

**KIT PART NUMBER**  
**RFD90102**  
[www.RFduino.com](http://www.RFduino.com)



**Shrunk down an Arduino to the size of a finger-tip and made it Wireless**

Bluetooth 4.0 Low Energy

Easy To Use Arduino IDE & Sketches Running On Professional Grade Hardware

Kit Includes:  
 (2 ea) RFD22102 RFduino DIP  
 (1 ea) RFD22121 USB Shield  
 (1 ea) RFD22122 RGB LED / Button Shield  
 (1 ea) RFD22123 Servo Shield  
 (1 ea) RFD22125 Prototyping Shield  
 (1 ea) RFD22126 Dual AAA Battery Shield

CE (ETSI) Compliant  
 IC & FCC Approved & Certified

RoHS

Batteries Not Included  
 Runs On 3V

Runs On 3V  
 No Soldering  
 Ultra Low Power  
 Bluetooth 4.0 LE  
 High Performance  
 Plugs Into Breadboards

www.RFDUINO.com

**RFduino**  
 Rapid Development & Prototyping

Based on RFD22301 RF Module

**KIT PART NUMBER**  
**RFD90105**  
[www.RFduino.com](http://www.RFduino.com)



**Shrunk down an Arduino to the size of a finger-tip and made it Wireless**

Easy To Use Arduino IDE & Sketches Running On Professional Grade Hardware

Kit Includes:  
 (10 ea) RFD22102 RFduino DIP  
 (2 ea) RFD22121 USB Shield  
 (2 ea) RFD22122 RGB LED / Button Shield  
 (2 ea) RFD22123 Servo Shield  
 (2 ea) RFD22124 PCB USB Shield  
 (2 ea) RFD22125 Prototyping Shield  
 (2 ea) RFD22126 Dual AAA Battery Shield  
 (2 ea) RFD22127 Single AAA Battery Shield  
 (2 ea) RFD22128 CR2032 Battery Shield  
 (2 ea) RFD22130 Micro SD Shield  
 (2 ea) RFD22131 Dual Relay Shield

CE (ETSI) Compliant  
 IC & FCC Approved & Certified

RoHS

Batteries Not Included

www.RFDUINO.com

Many different Eval and Dev Kits available on <http://www.rfduino.com/>

## FCC Compliance Information

The RFD22301 is IC and FCC Modular Approved and Certified, therefore for use of the RFD22301 module in your product does not require further IC or FCC testing for an intentional radiator for compliance of the RFD22301. Detail instructions and IC and FCC notices shown later in this data sheet. Any modifications made to the RFD22301 will void the IC and FCC Approval and Certification. The RFD22301 has an integrated on-board chip antenna. You simply include the RFD22301 in your product and follow the IC and FCC notices and information below and place the appropriate label on your product to indicate that it includes an IC and FCC approved module and no further testing would be required for the module.

The RFD22302 is NOT IC or FCC Approved since the antenna is not integrated as part of the module. However it is exactly the same as the RFD22301 except it does not have an internal antenna and is built to allow a user to apply their own antenna of choice. Any type of 2.4 GHz antenna may be used. Once you include the RFD22302 into your product and your chosen antenna is connected, then your whole product is tested by an approved IC or FCC compliance laboratory and you receive your own grant for your whole product which includes the RFD22302. This procedure is somewhat costly and time consuming and therefore the RFD22301 is the primary choice by many engineers. The RFD22302 is typically used if you must have an external antenna.

## CE, ETSI Compliance Information

The RFD22301, RFD22302, RFD21742 and RFD21743 are CE (ETSI) Tested. See declaration of conformity later in this document.

## Using CR2032 Batteries

The CR2032 battery is very commonly used for power. The peak current draw for the Modules are about 15mA, and the background current is 5uA depending on the mode setting of course. Quite often capacitors are used in parallel with the CR2032 to help limit the amount of peak current the CR2032 is exposed to, so as to help it have a longer run time, since the CR2032 does not handle peak current very well over long durations of time. We recommend if you choose to place bypass capacitors tied to the CR2032 for this purpose, then do testing to compare if they really provide you a benefit or not. Quite often the leakage current of the capacitors are so high that they will have negative impact on the battery runtime rather than provide an advantage. At least if you have the room, place the pads, but before you place the caps for production, do testing to make sure they are really helping and not reducing your runtime.

## Industry Canada Information

*This device complies with Industry Canada licence-exempt RSS standard(s). Operation is subject to the following two conditions: (1) this device may not cause interference, and (2) this device must accept any interference, including interference that may cause undesired operation of the device.*

*Le présent appareil est conforme aux CNR d'Industrie Canada applicables aux appareils radio exempts de licence. L'exploitation est autorisée aux deux conditions suivantes : (1) l'appareil ne doit pas produire de brouillage, et (2) l'utilisateur de l'appareil doit accepter tout brouillage radioélectrique subi, même si le brouillage est susceptible d'en compromettre le fonctionnement.*

## IC LABEL

Relating to Model Number R25 (RFD Part Number: RFD22301)

The unit should have a permanently attached label in a conspicuous location with the following statement:

**Contains IC: 6992A-25**

### NOTES:

1. Industry Canada does not specify the size of the label or the lettering thereon. The only requirement is that the text be legible.



## **SAMPLE FCC STATEMENT TO BE INCLUDED IN USER'S MANUAL**

### **Relating to Model Number R25 (RFD Part Number: RFD22301)**

#### **INSTRUCTION TO THE USER (if device DOES NOT contain a digital device)**

The user is cautioned that changes or modifications not expressly approved by the party responsible for compliance could void the user's authority to operate this equipment.

#### **INSTRUCTION TO THE USER (if device contains a digital device)**

This equipment has been tested and found to comply with the limits for a class B digital device, pursuant to part 15 of the FCC Rules. These limits are designed to provide reasonable protection against harmful interference in a residential installation. This equipment generates, uses and can radiate radio frequency energy and if not installed and used in accordance with the instructions, may cause harmful interference to radio communications. However, there is no guarantee that interference will not occur in a particular installation. If this equipment does cause harmful interference to radio or television reception, which can be determined by turning the equipment off and on, the user is encouraged to try to correct the interference by one or more of the following measures:

- \* Reorient or relocate the receiving antenna.
- \* Increase the separation between the equipment and receiver.
- \* Connect the equipment into an outlet on a circuit different from that to which the receiver is connected.
- \* Consult the dealer or an experienced radio/TV technician for help.

In order to maintain compliance with FCC regulations, shielded cables must be used with this equipment. Operation with non-approved equipment or unshielded cables is likely to result in interference to radio and TV reception. The user is cautioned that changes and modifications made to the equipment without the approval of manufacturer could void the user's authority to operate this equipment.

## FCC LABEL

### Relating to Model Number R25 (RFD Part Number: RFD22301)

The unit should have a permanently attached label in a conspicuous location with the following statement:

**Contains FCC ID: UYI25**

**This device complies with Part 15 of the FCC Rules.  
Operation is subject to the following two conditions:**

- (1) This device may not cause harmful interference and**
- (2) this device must accept any interference received,  
including interference that may cause undesired  
operation.**

#### NOTES:

1. The FCC does not specify the size of the label or the lettering thereon. The only requirement is that the text be legible.
2. If the entire label can not be placed on the unit due to space constraint, only FCC ID may be displayed on the unit. In such cases, the compliance statement will have to be included in the "user's manual". NOTE: Device must be smaller than a man's palm.

\*\* If the unit also interfaces with phone line, it requires additional information on the label - refer to part 68 information \*\*

**RoHS**  
**Declaration Of Conformity**  
**November 17, 2013**

**RF Digital declares that part numbers**

- **RFD22301**
- **RFD22302**

**are manufactured with RoHS materials.**

## DECLARATION OF CONFORMITY

November 17, 2013

RF Digital declares that part numbers

- RFD22301
- RFD22302

comply with ETSI EN 300 440-2 power requirements

as called out in the R&TTE V1.2.1 Directive

Technical documents for the above mentioned part numbers are held at

**RF Digital Corporation**  
1601 Pacific Coast Highway, Suite 290  
Hermosa Beach, CA 90254

**Overall Dimensions • Top View**

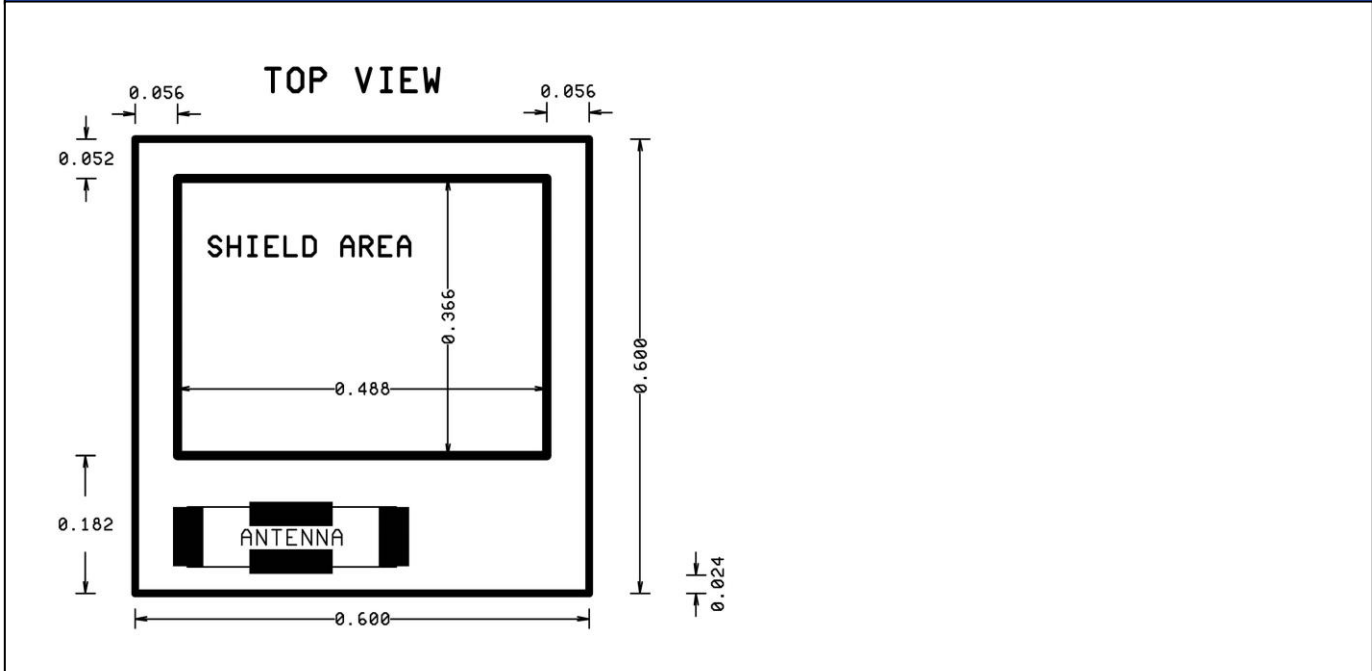

**Overall Dimensions • Side View**

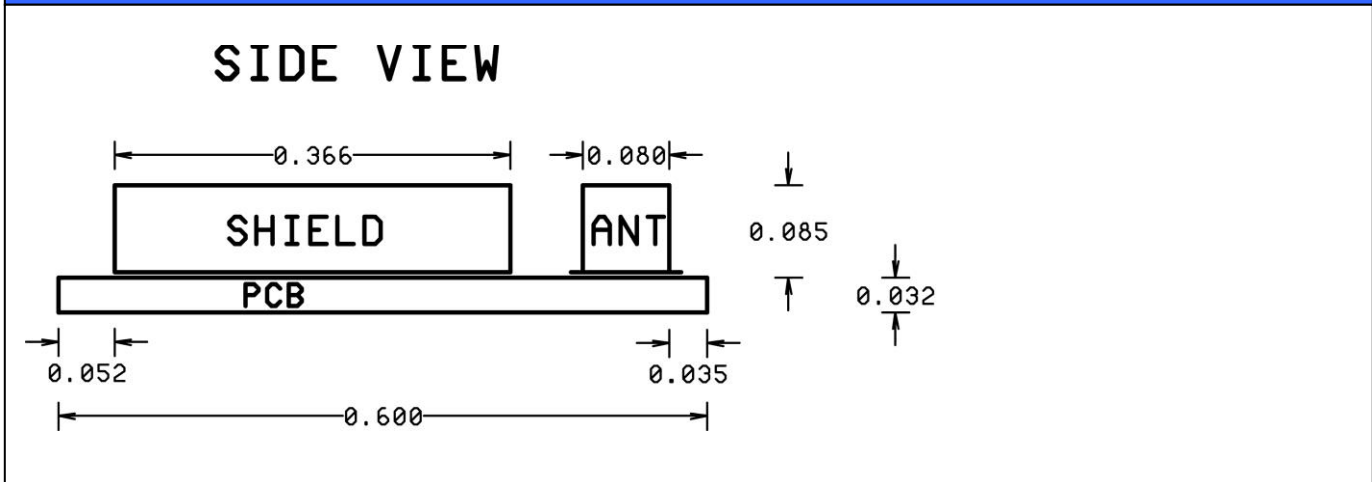

**PCB Layout**

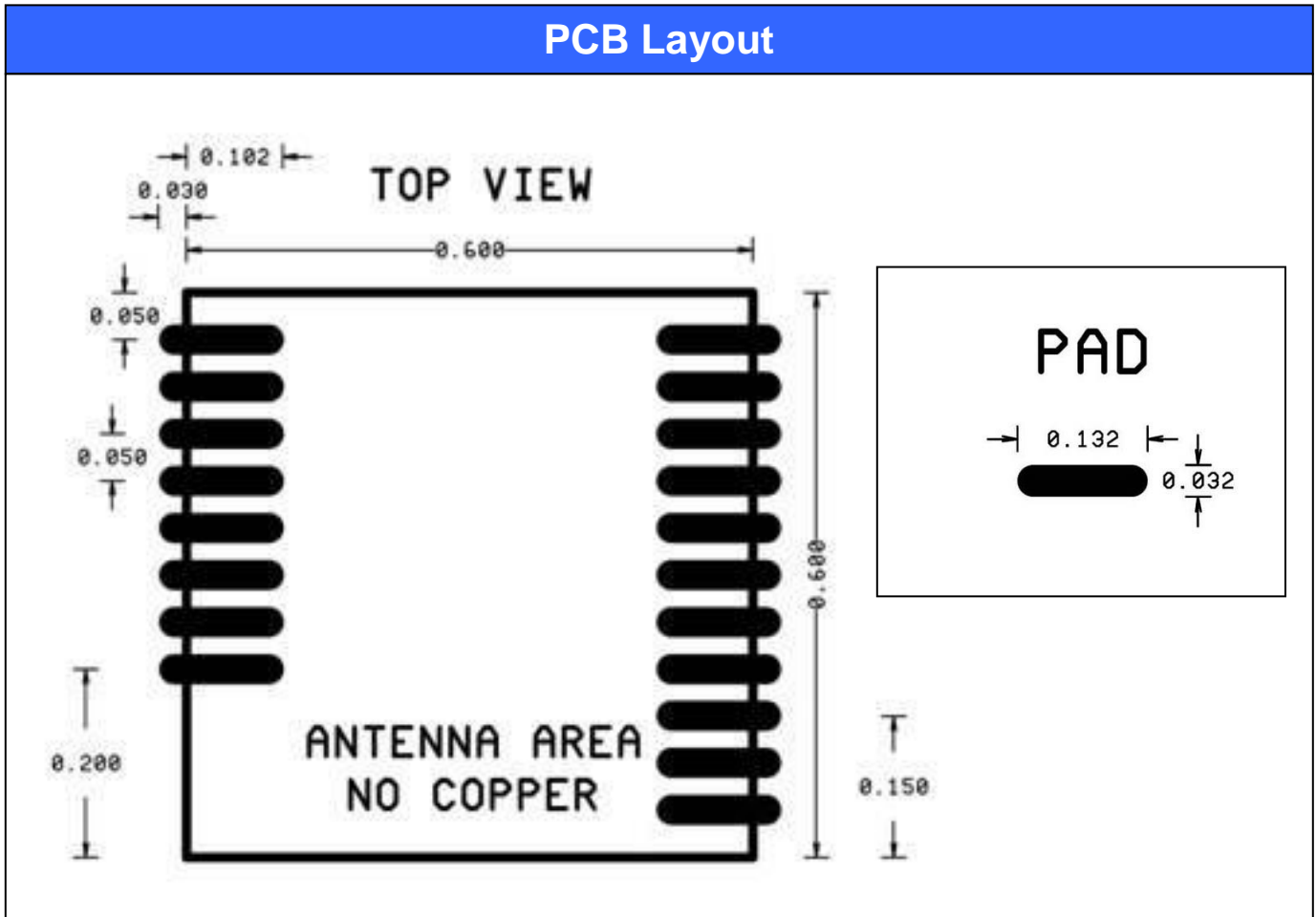

## Washing

**The RFD22301 and RFD22302 are NOT washable.**

Use no-clean flux, leaded or lead-free. If you attempt to wash the modules, water will enter beneath (inside) the RF shield and get trapped, which may cause device failure or damage once powered on. There is no way to make sure all water has been removed before powering the module so do NOT wash the modules.

## Potting, Encapsulation and Conformal Coating

**Do NOT pot or conformal coat the RFD22301 or RFD22302.**

If you plan on encapsulating the RFD22301 or RFD22302 in a potting compound or conformal coating, you must assure that the compound in liquid or solid form does not enter under the shield where there are sensitive RF components. Some of the capacitive values are as low as half a picofarad and sensitive to contacting materials such as potting compounds. There are potting compounds and conformal coatings which have very good dielectric constants and are suitable for 2.4 GHz potting applications, however, when you apply any of these, they were accounted for in the circuit design and might reduce performance of the device or all together cause it not to function.

**Applying any compound, conformal coating or potting directly to the module voids any and all warranty and support service.**

If your application requires 100% sealing of the module, there is a way to do this very successfully without impacting the module performance. Simply place the module on your PCB. Place a plastic cover over the module (like a hat), make the cover large enough to cover the whole module. Apply glue around the bottom perimeter of the cover where it sits on the PCB. This allows the module to function in free airspace while there is a complete seal around it. This information is only for reference and you should do your own testing with your application to find the best suitable fit for your own design.

## Reflow Profile

Use standard lead-free or leaded reflow profile for the RFD22301 and RFD22302. Your CM (Contract Manufacturer) should profile this module along with your PCB and all other parts on it through their reflow oven to properly set a profile suitable for all the parts on the board combined.

**USE CAUTION:** If you are building a double-sided placement board, place this device last so it will not be subjected to being reflowed upside-down.

As with building any RF devices, you should always build a small quantity through your production process, test and verify, then increase your quantities to make sure the process is not harmful to the performance of your RF system. This is true with any RF system, including use of these modules.

**RFD22301 / RFD22302 Tray Packaging**

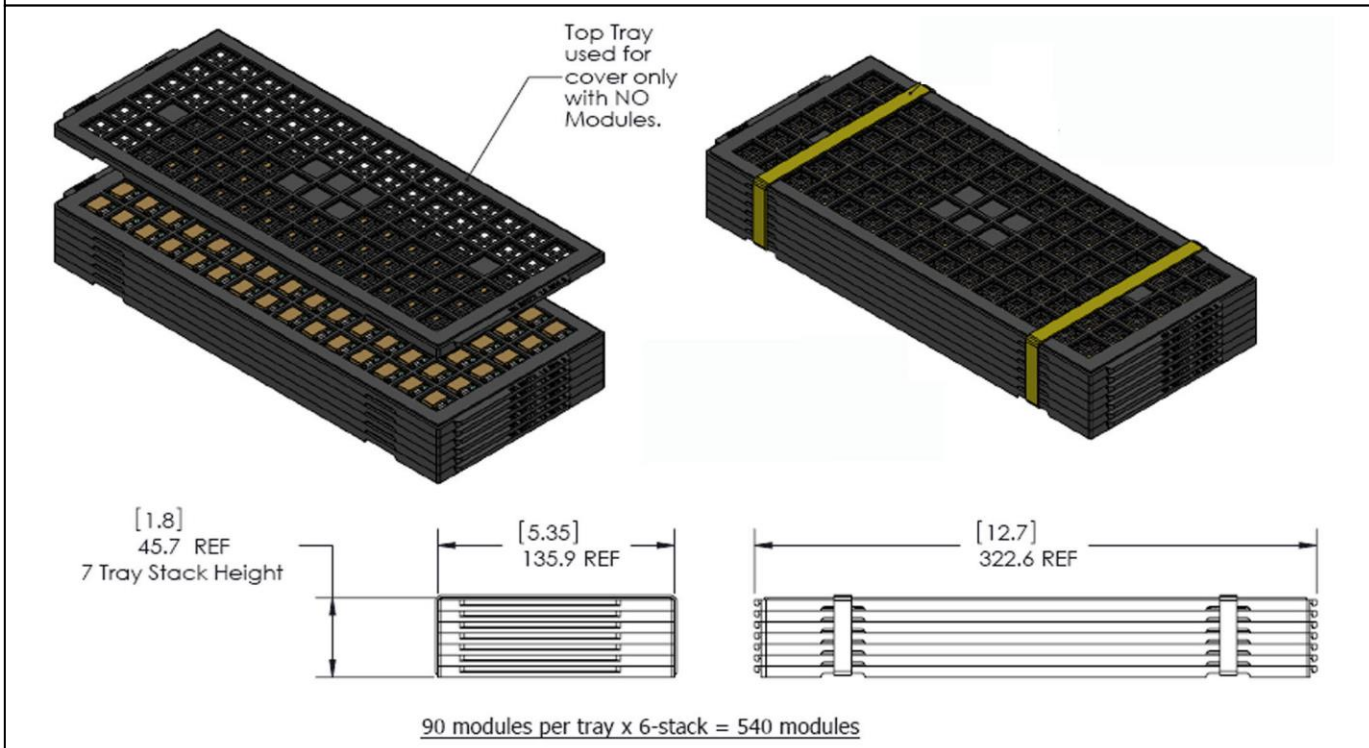
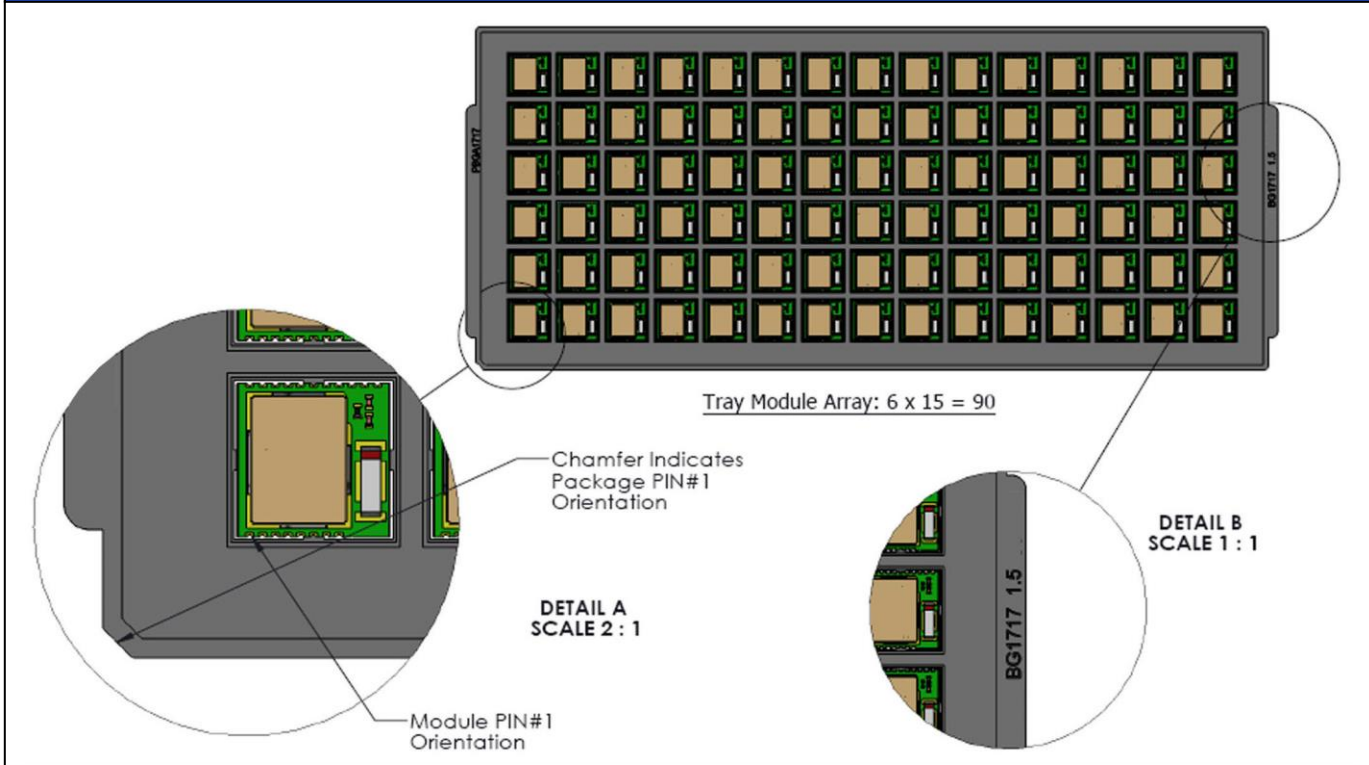



## RFD22301 / RFD21735 Tray Packaging

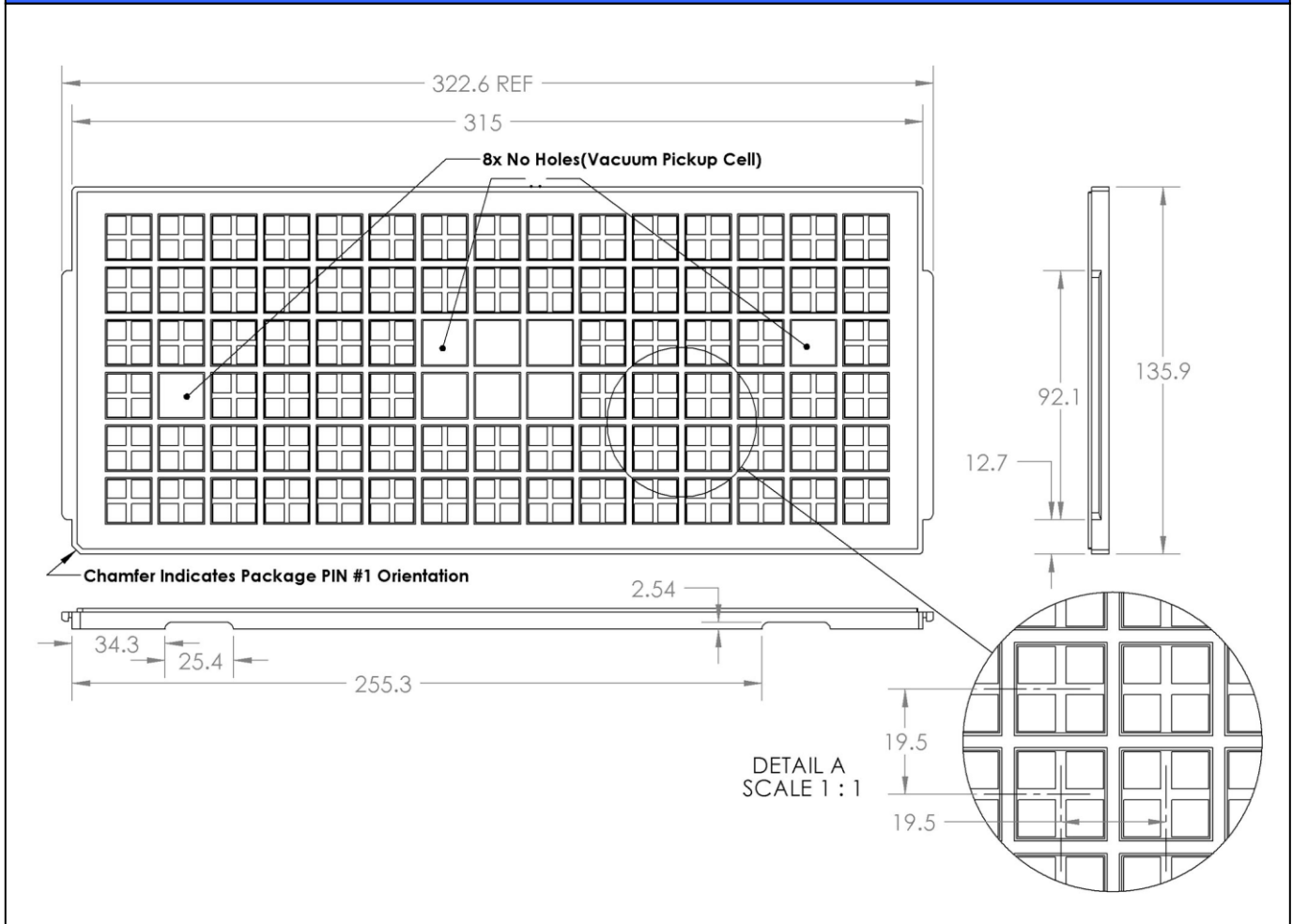

## RFD22301 / RFD22302 Tray Packaging

7 Trays total, including 1 blank top tray

90 modules per tray x 6-stack = 540 modules

Top Tray  
used for  
cover only  
with NO  
Modules.

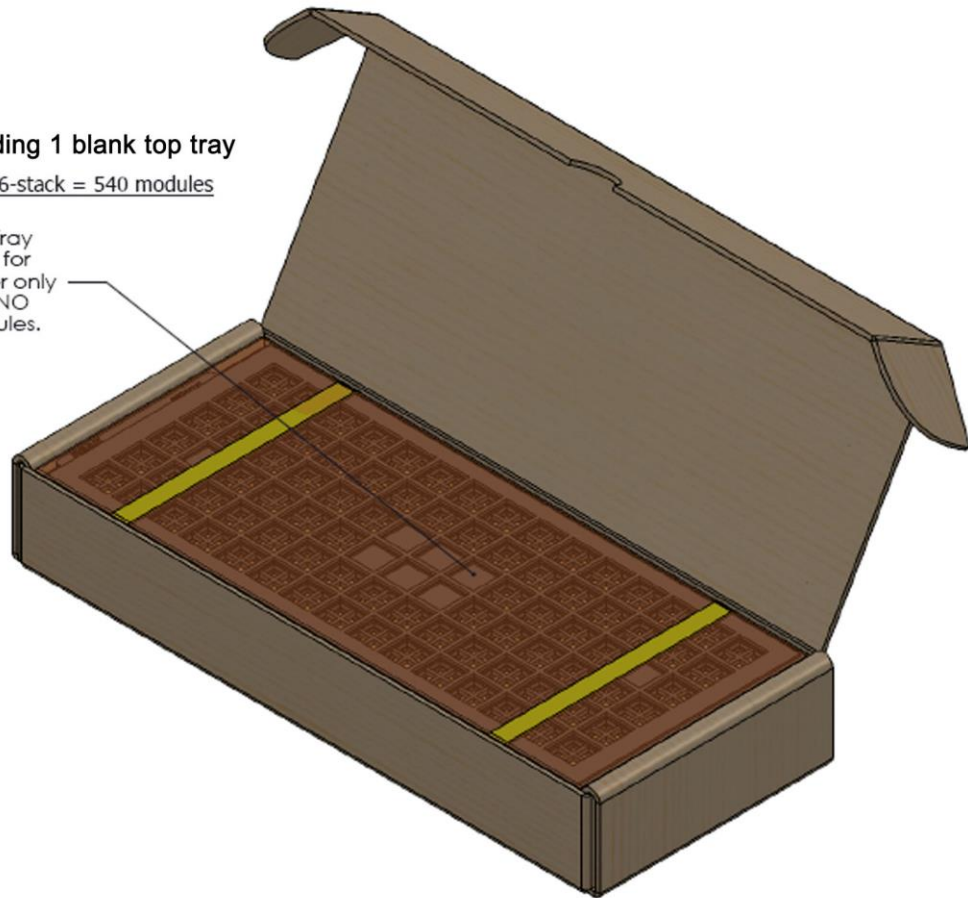

## Surface Mounted RF Module Layout Examples

For Part Numbers RFD22301 and RFD22302

### Layout Trace Routing and VIAs

When doing your layout for the RFD21733 and RFD21735 avoid placing routs under the module if at all possible. Having traces under the module as long as they are fully covered by soldermask is typically fine, however placing VIAs under the module is not at all recommended since soldermask covering VIAs are typically not fully plugged and protected. Therefore, if there is any exposes soldermask under the module near an area were your board has an exposed via, there is a chance of a short. There is a slim chance of this ever happening, however if possible, make effort to avoid having VIAs under the Modules.

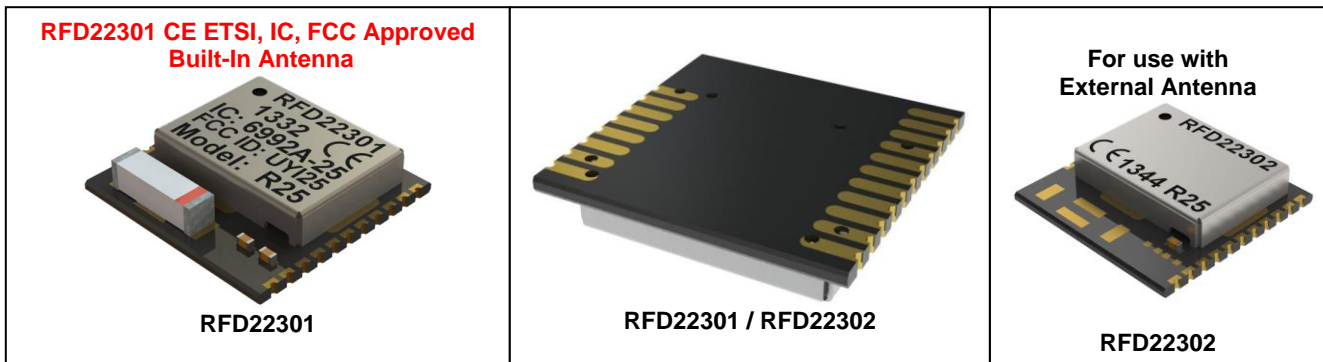

### Legend

Please use the legend below to identify the colors, objects and their meanings in this document.



## RFD22301 Layout Example Pinout

This Layout Examples document only references pins that are common to all RFD22301 and RFD22302 modules and matter to the layout, which are ground and external antenna connections where applicable. To keep the file size of this document small, some of the larger images are outputted in lower resolutions, for full details on pinouts refer to the data sheet for the appropriate part number, which can all be found at <http://www.rfdigital.com>.

Pins labels 3,4,5,6,7,14,15,16,17 change based on which part number module is being used, however that does not matter for this document.

If you have any questions, feel free to contact RF Digital Support anytime, we're always here to help you!

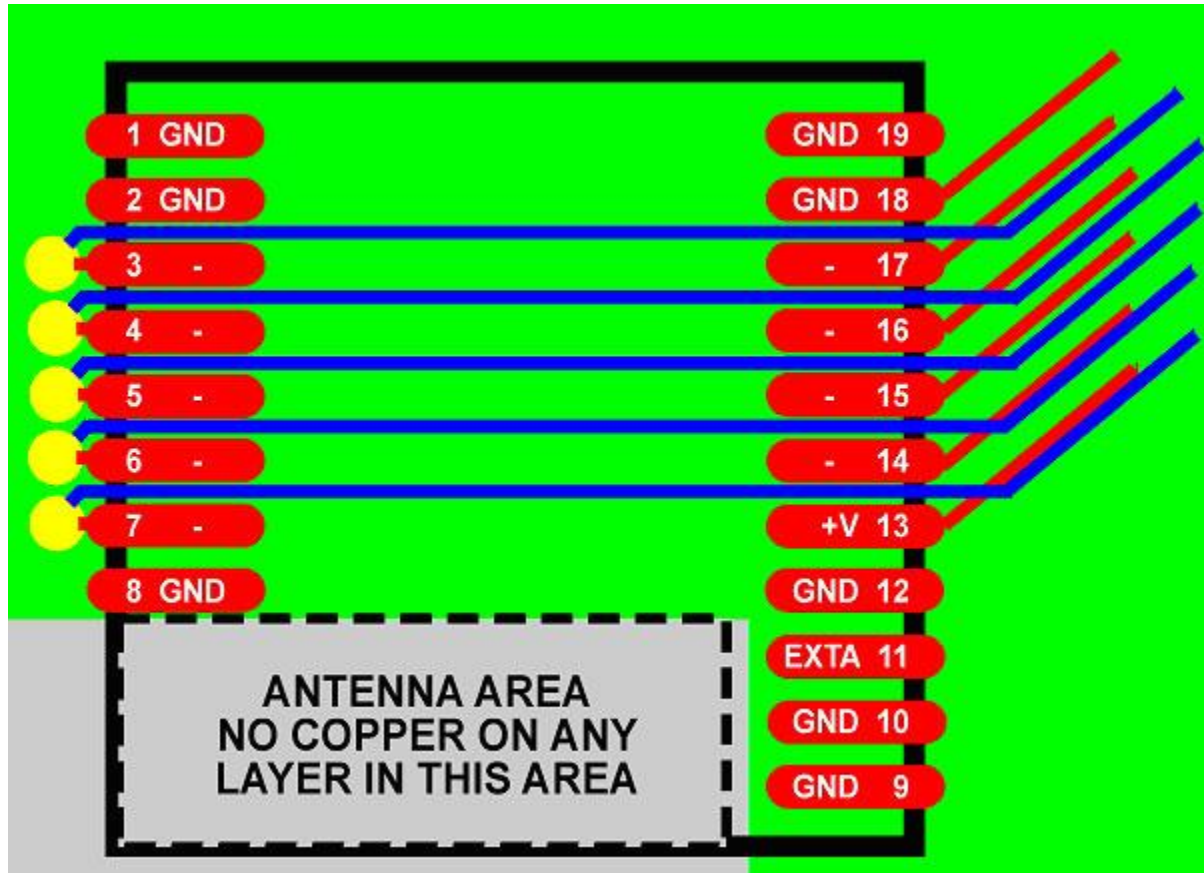

## RFD22301 Layout Examples

The following layout examples are for the RFD22301 module which has a built-in chip antenna. Later in this document there are examples for the RFD22302 module which is for use with external an antenna.

## RFD22301 Antenna Pattern

This is a typical antenna pattern, however does vary based on many factors including surrounding components and ground planes. It is only provided as a reference. The one inch copper plane shown helps maintain the balanced antenna pattern and when possible should be used, if not possible, its not required.

## Antenna Pattern

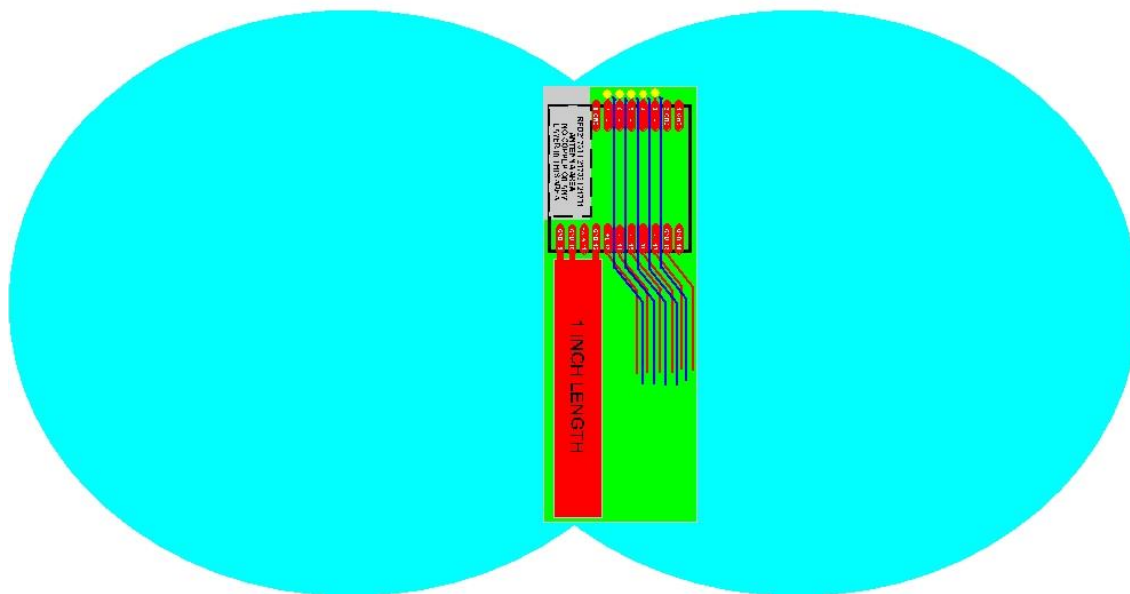

## RFD22301 Keep Out Area - Example 1

When placing the module into a plastic enclosure, it is highly recommended that you locate the module in the corner of the enclosure / PCB so it will be as far away from your other components on the PCB and as close to free airspace as possible. In addition, you want to locate the module in a position in your product where it will have as much free airspace as possible near the antenna when in use. For example if it will be placed against a wall, it is preferred to locate the module so it will be in a location in your product where it will be on the side of the product where it will be further away from the wall, rather than directly next to it, so the RF signal can have as much free airspace to give you the best range performance possible. (Note: If you plan on using a metal enclosure, you can not locate the module inside of the enclosure or it will have very limited range.)

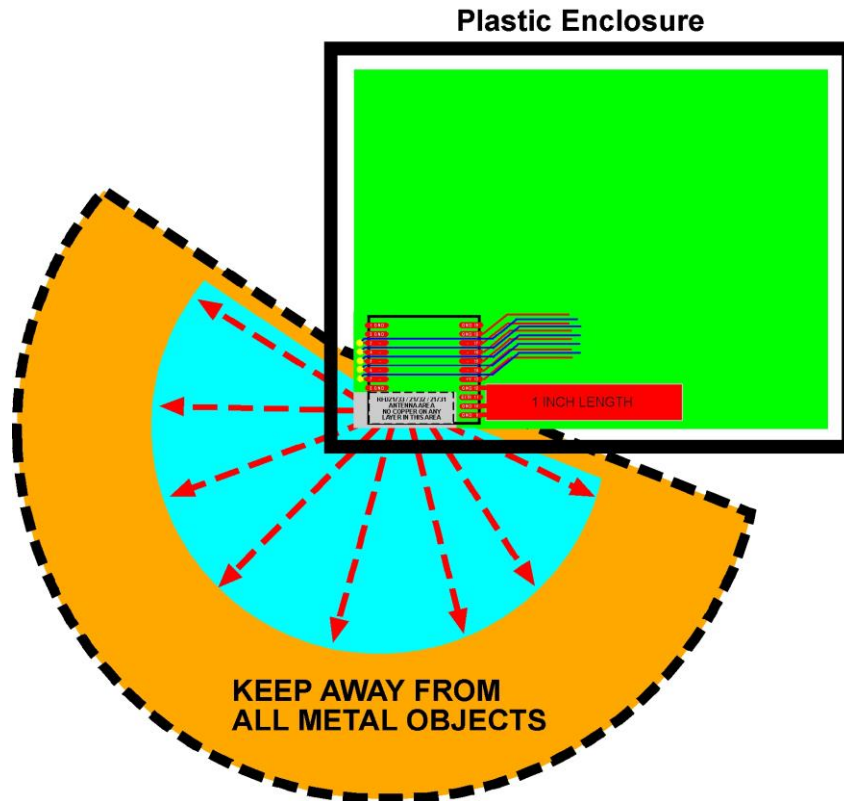

RF Signals in this area.

If you place anything such as components, wires, metal parts of any type in this area, it will block the RF signals and drastically limit your range. Leave this area open.

## RFD22301 - Layout Examples 2

The gray area shows where to keep free from copper and components. The one-inch length copper area is optional, however does improve the range if you can add it. Parts can be placed all over the rest of the board, however if possible keep about a half-inch distance from the one inch length ground area to the right of the module, again, only if possible. Also the signal connections to the module can be made on either layer. The electrical ground connection to the module is to be made with a thin trace so the one inch ground plane off to the side can be effective.

### Plastic Enclosure

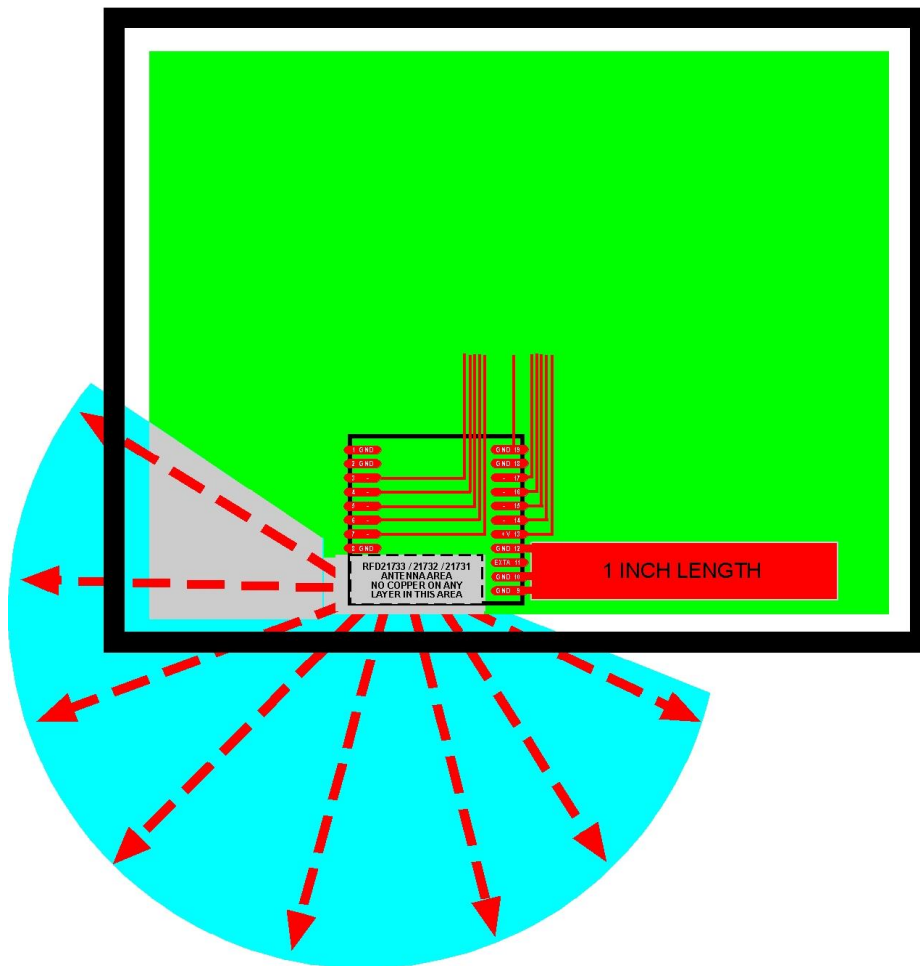

RF Signals in this area.

If you place anything such as components, wires, metal parts of any type in this area, it will block the RF signals and drastically limit your range. Leave this area open.





## RFD22301 - Layout Examples 4

The gray area shows where to keep free from copper and components. The one-inch length copper area is optional, however does improve the range if you can add it. Parts can be placed all over the rest of the board, however if possible keep about a half-inch distance from the one inch length ground area to the right of the module, again, only if possible.

### Plastic Enclosure

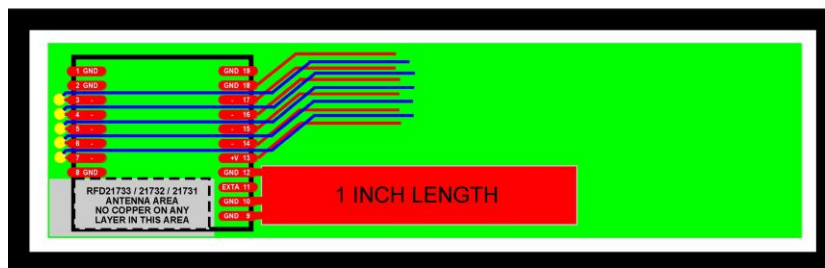

### Plastic Enclosure

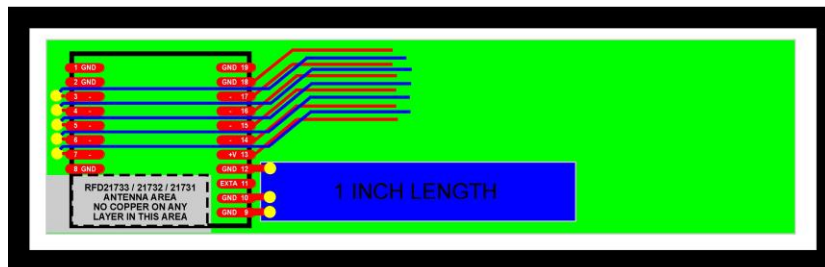

### Plastic Enclosure

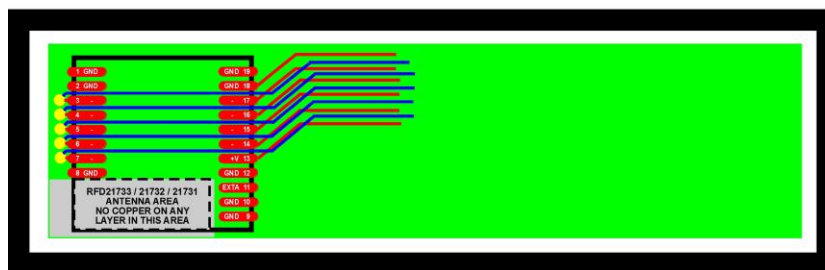



## RFD22301 - Layout Examples 6

The gray area shows where to keep free from copper and components. The one-inch length copper area is optional, however does improve the range if you can add it. Parts can be placed all over the rest of the board, however if possible keep about a half-inch distance from the one inch length ground area to the right of the module, again, only if possible.

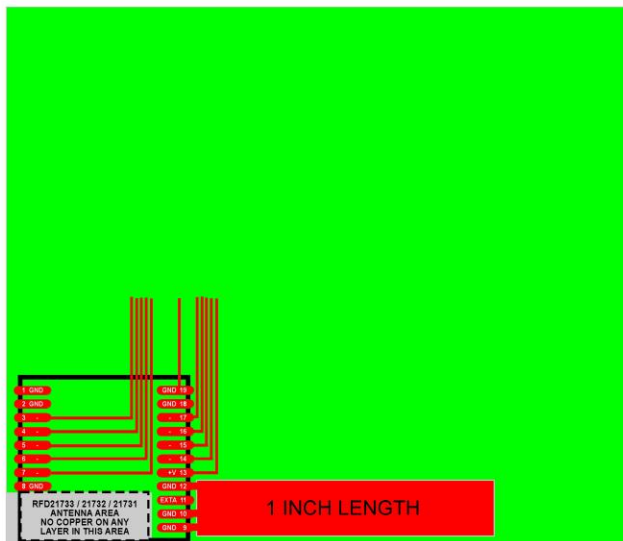
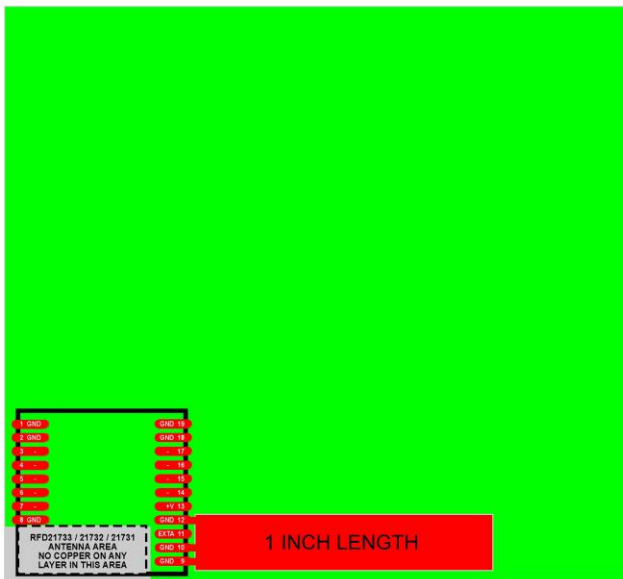
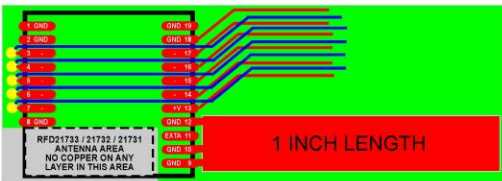
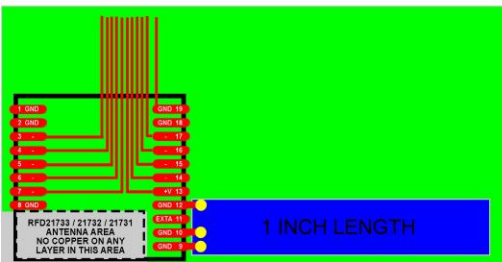
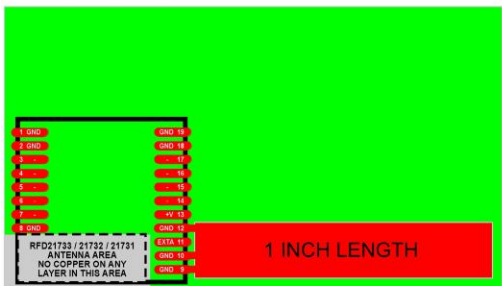

## RFD22301 - Layout Examples 7

The gray area shows where to keep free from copper and components. The one-inch length copper area is optional, however does improve the range if you can add it. Parts can be placed all over the rest of the board, however if possible keep about a half-inch distance from the one inch length ground area to the right of the module, again, only if possible. Solid blue areas are solder side ground plane which can be used for user electronics as well as the module. These are all optional configurations and only for reference.

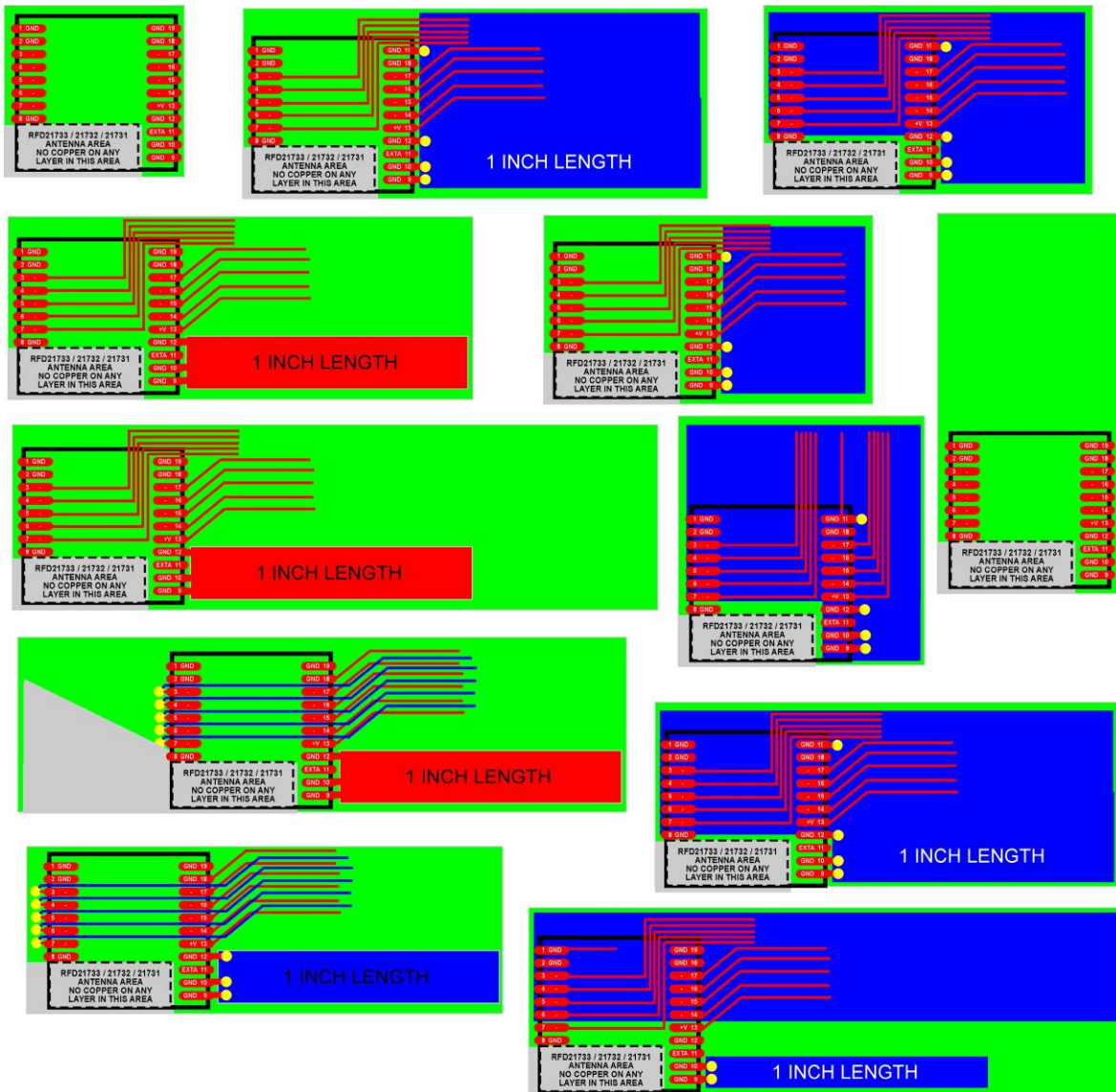

## RFD22301 - Layout Examples 8

The gray area shows where to keep free from copper and components. The one-inch length copper area is optional, however does improve the range if you can add it. Parts can be placed all over the rest of the board, however if possible keep about a half-inch distance from the one inch length ground area to the right of the module, again, only if possible. Solid blue areas are solder side ground plane which can be used for user electronics as well as the module. These are all optional configurations and only for reference. The two left examples are preferred, but the two right ones will work as well, but will not have as good of an antenna pattern.

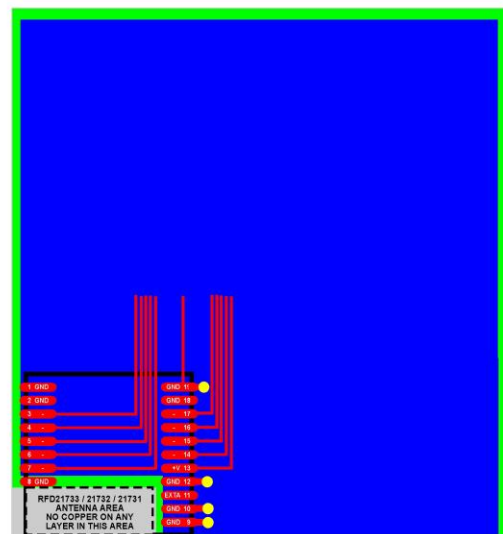
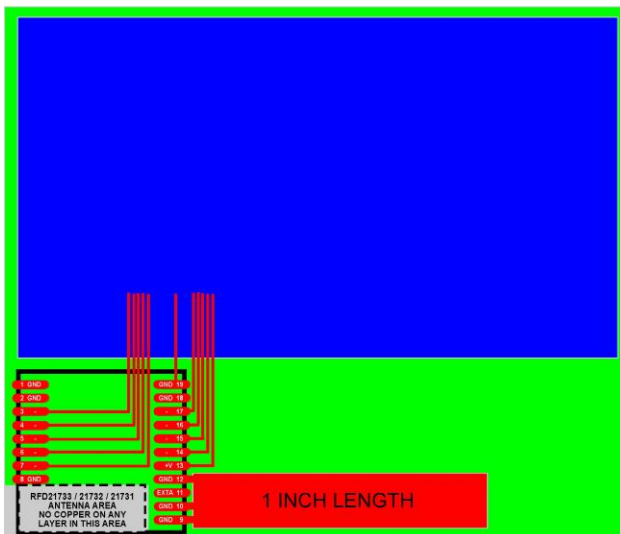
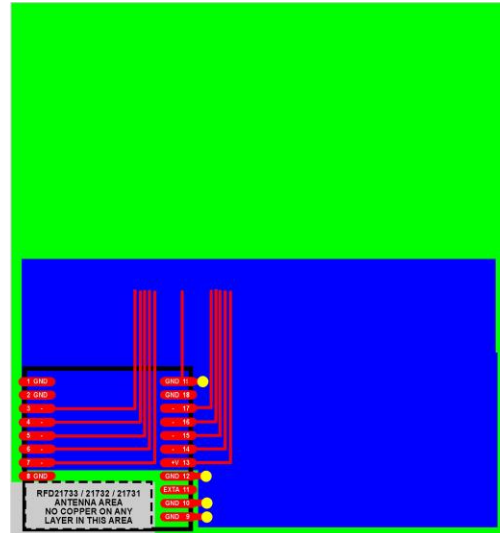
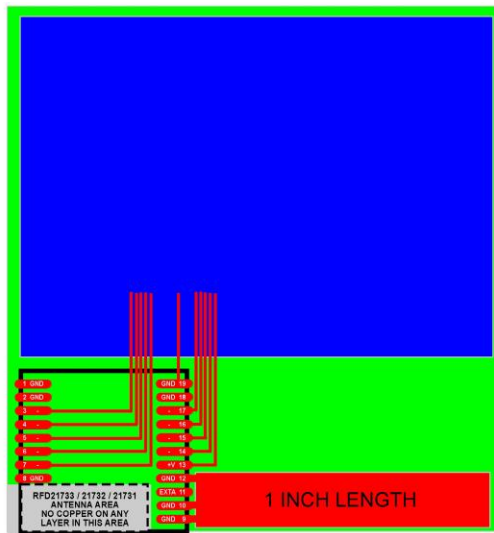

## RFD22301 - Layout Examples 9

The gray area shows where to keep free from copper and components. The one-inch length copper area is optional, however does improve the range if you can add it. Parts can be placed all over the rest of the board, however if possible keep about a half-inch distance from the one inch length ground area to the right of the module, again, only if possible. Solid blue areas are solder side ground plane which can be used for user electronics as well as the module. These are all optional configurations and only for reference. The two left examples are preferred, but the two right ones will work as well, but will not have as good of an antenna pattern.

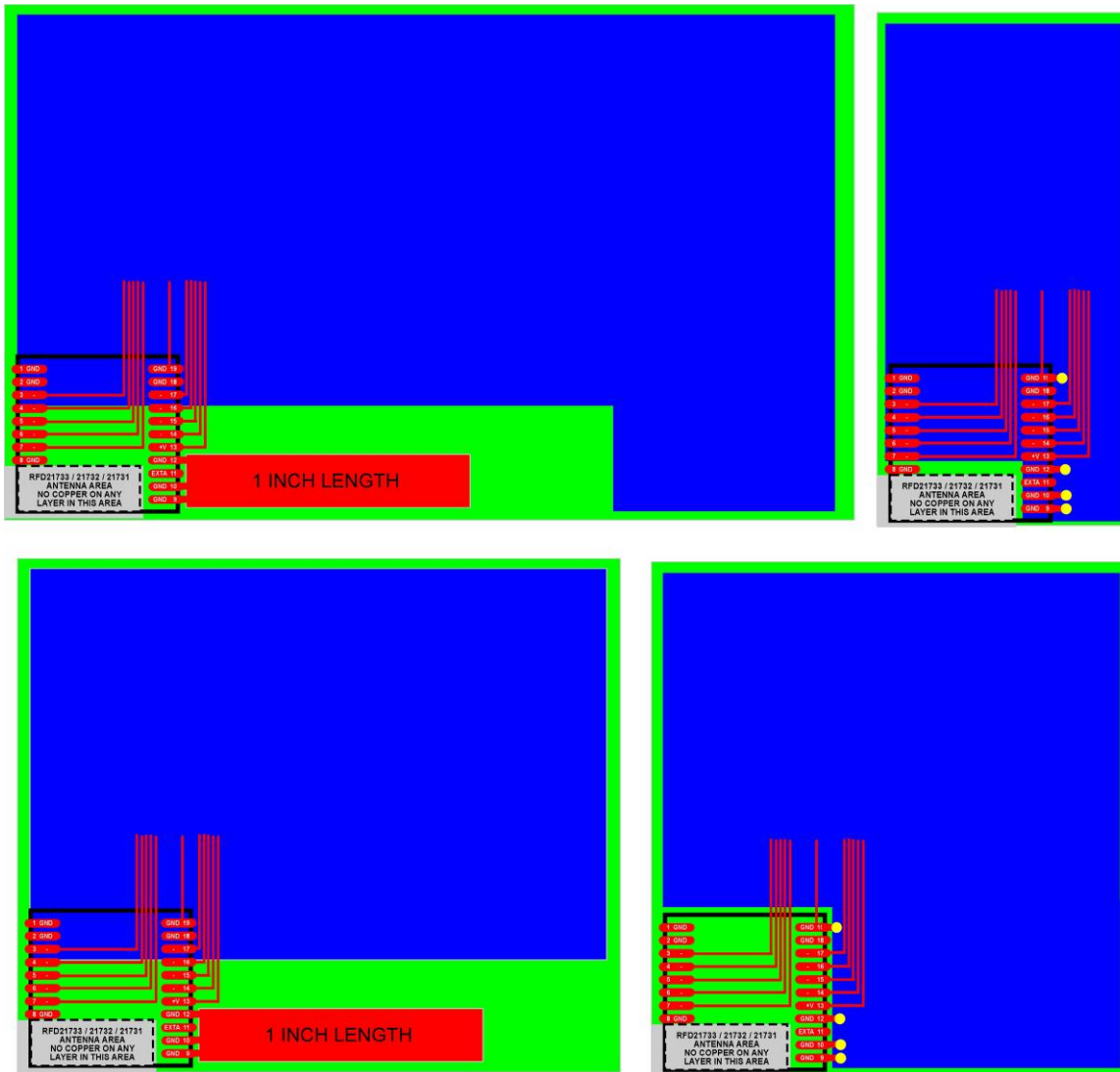

## RFD22301 - Layout Examples 10

The gray area shows where to keep free from copper and components. The one-inch length copper area is optional, however does improve the range if you can add it. Parts can be placed all over the rest of the board, however if possible keep about a half-inch distance from the one inch length ground area to the right of the module, again, only if possible. Solid blue areas are solder side ground plane which can be used for user electronics as well as the module. These are all optional configurations and only for reference. The space in the ground plane helps provide some RF discontinuity for the module to have the best antenna pattern possible in this configuration, the optimal space to have is greater than 1.2 inches, but some space is better than no space.

### BEST

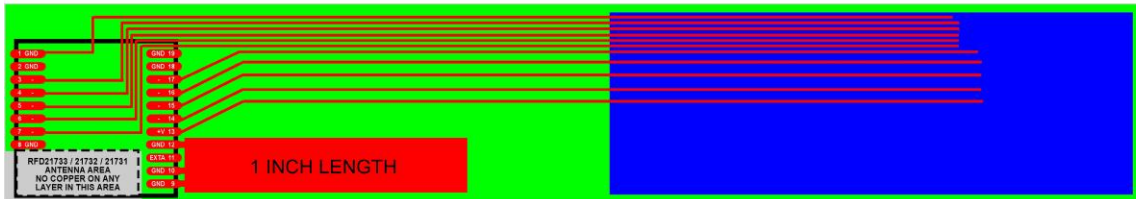
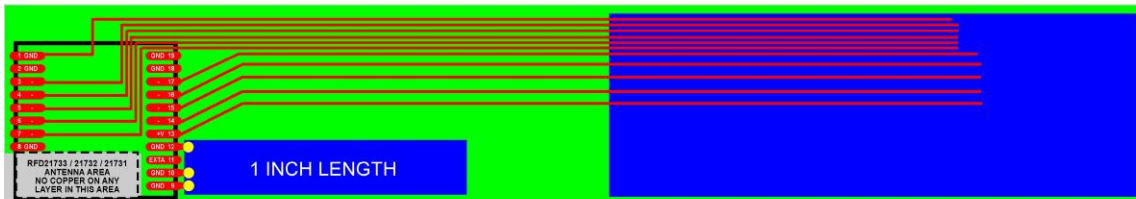

### BETTER

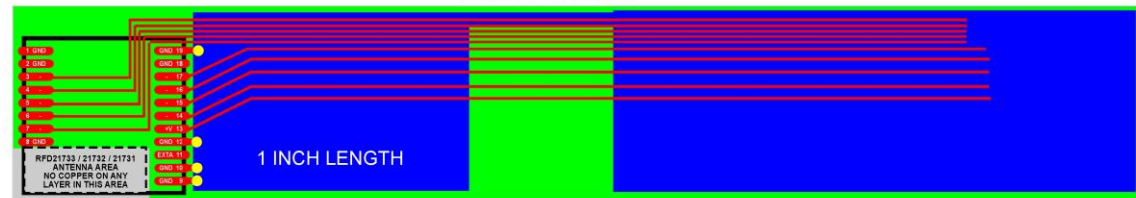

### GOOD

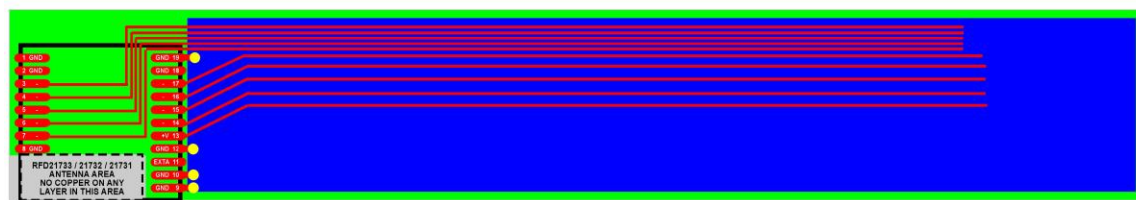

## RFD22301 - Layout Examples 11

The gray area shows where to keep free from copper and components. These shown are not good layout locations for the module since they take up most of your board area, it is best to locate the module similar to the examples shown in other areas of this document where you have more board space for your parts. These examples are shown as what NOT to do. If you place parts in the gray area, it will result in very bad range performance.

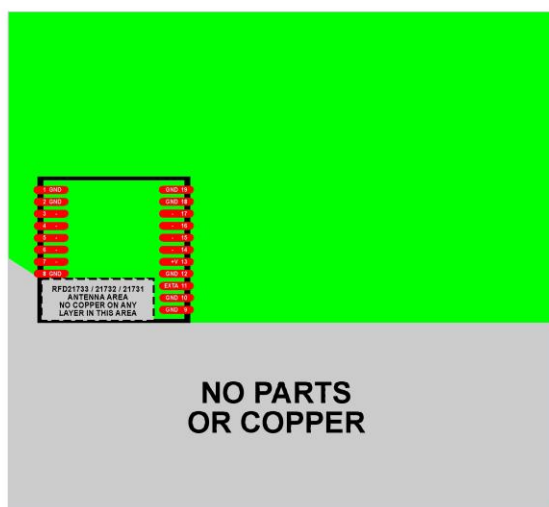
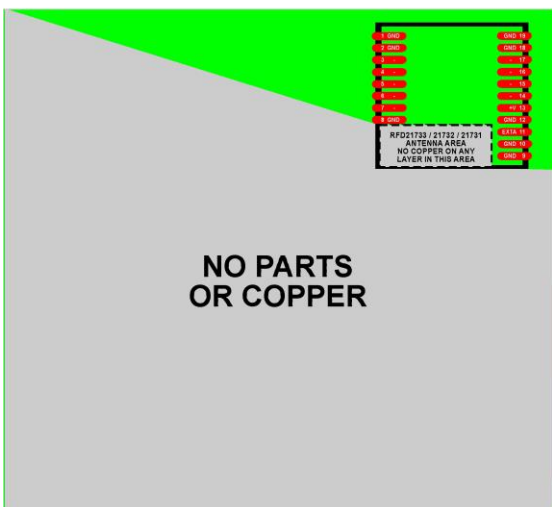
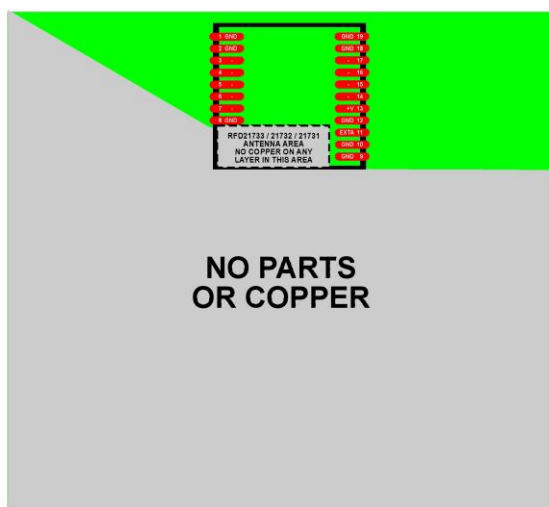
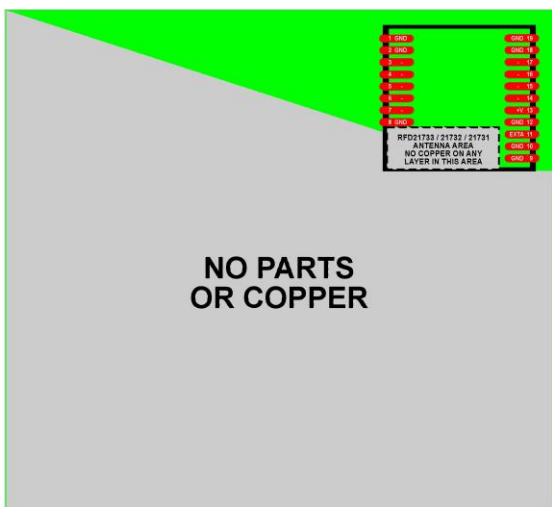



## RFD22301 - Layout Examples 12

The gray area shows where to keep free from copper and components. These shown are not good layout locations for the module since they take up most of your board area, it is best to locate the module similar to the examples shown in other areas of this document where you have more board space for your parts. These examples are shown as what NOT to do. If you place parts in the gray area, it will result in very bad range performance.

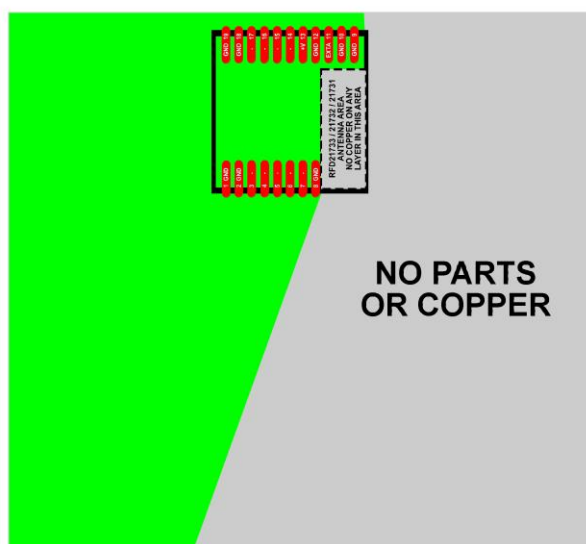
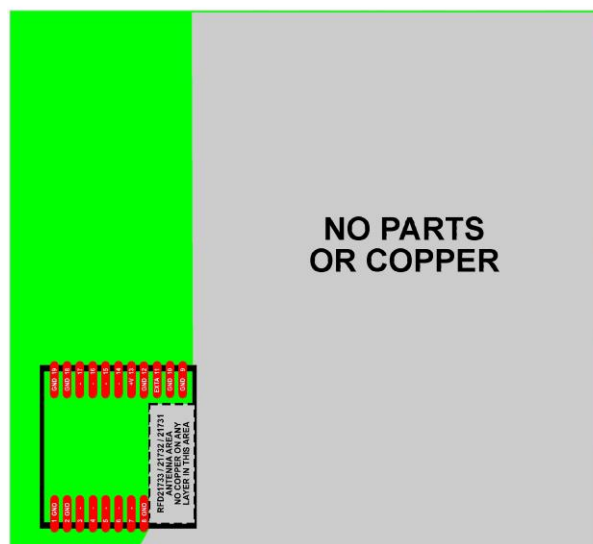
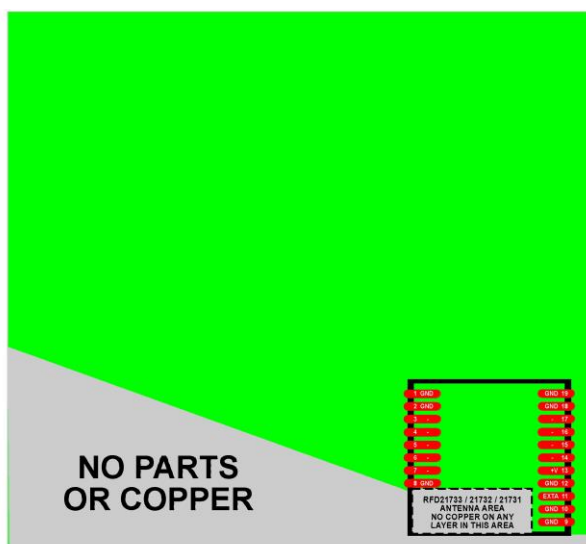
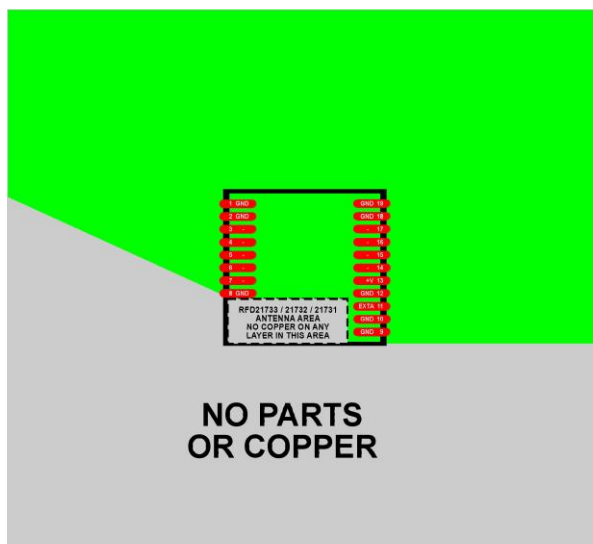

## RFD22301 - Layout Examples 13

The gray area shows where to keep free from copper and components. These are multi-module configurations. Typical layouts for diversity applications where you will use multiple receivers, transmitters or transceivers all on the same board to limit multipath impacts and increase effective communication range or provide a very solid coverage area with limited dead-zones. The distances shown are not optimal, however just provided as reference.



## RFD22301- Layout Examples 14

The gray area shows where to keep free from copper and components. These are multi-module configurations. Typical layouts for diversity applications where you will use multiple receivers, transmitters or transceivers all on the same board to limit multipath impacts and increase effective communication range or provide a very solid coverage area with limited dead-zones. The distances shown are not optimal, however just provided as reference.

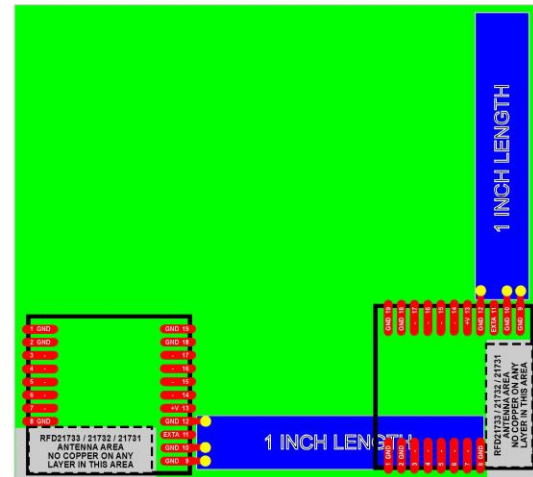
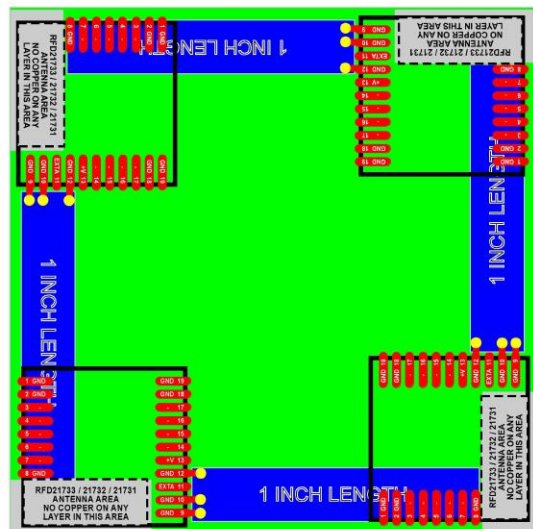
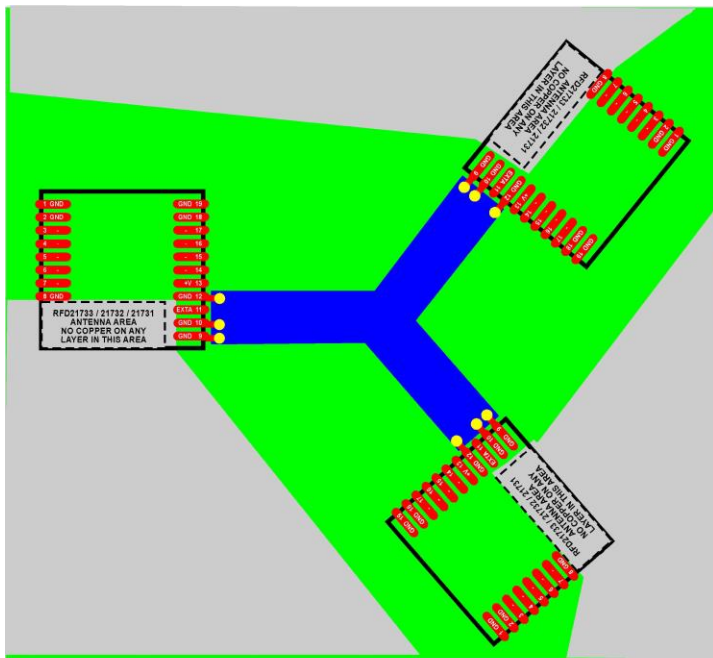

## RFD22302 - Layout Examples 15

The gray area shows where to keep free from copper and components. The RFD22302 requires the use of an external antenna and therefore the most common connector used for this is an SMA and the examples below show a typical SMA connector footprint interface.

PCB thickness is 0.031 inch to 0.062 inch, double sided. The blue color shows ground plane under the module on the solder side of the board.

If you place ground plane or any traces under the gray area marked no-copper, then you will not have the option to use the RFD22301 which is the on-board chip antenna version of the RFD22302. So it is your choice if you choose to flood copper under that area or not. There is no benefit to flood copper in that area. If you choose to make a dual-mode layout to handle both module options, with chip antenna or without (which is what we recommend), then also advise with the layout configurations above for proper application.

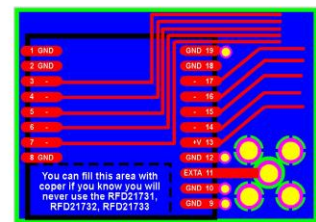
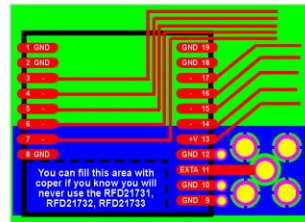
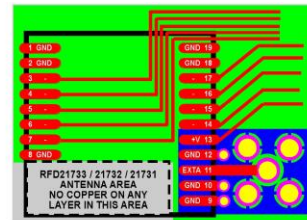
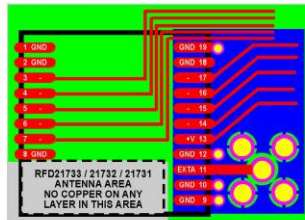
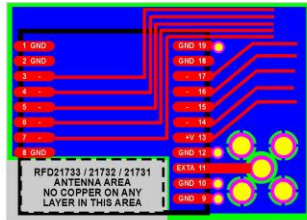

## Important Notice

RF Digital reserves the right to make corrections, modifications, and/or improvements to the product and/or its specifications at any time without notice.

RF Digital assumes no liability for the user's product and/or applications.

RF Digital products are not authorized for use in safety-critical applications, including but not limited to life-support applications.

RF Digital assumes no liability for parts or their application beyond replacement or refunding the original purchase price.

All trademarks and trade names belong to their respective owners.

Information provided in this document is for reference only. The user must conduct testing and prototyping on their own for their own application. This document only provides an example of a possible use for the parts shown in this design and requires actual testing to confirm its accuracy or validity or proper application. There is NO suggestion that the devices shown in this document should be used for the implied application. There is no guarantee or warranty of suitability for any specific application. The information disclosed in this document is AS-IS. By using any information contained in this document you are assuming all risks and liability associated therewith. RF Digital reserves the right to make corrections, modifications, changes and/or improvements to specifications or details at any time without notice or obligation. RF Digital assumes no liability for the user's product and/or applications. RF Digital products are not authorized for use in safety-critical applications, including but not limited to life-support applications. RF Digital assumes no liability for parts or their application beyond replacement or refunding the original purchase price paid to RF Digital.

## Limited Product Warranty

RF Digital warrants that RF Devices manufactured by RF Digital are free from defects in material and workmanship, for Ninety (90) Days from date of delivery. RF Devices covered by this warranty and returned to RF Digital within the Ninety Day Warranty Period will be eligible for replacement, repair, or credit, limited to the amount RF Digital was paid for the RF Device. To obtain a remedy under this Warranty, the following conditions must be met: (1) Customer must notify RF Digital in writing promptly on discovery of the deficiency with reasonable detail within the Warranty Period; (2) Customer must return the RF Devices to RF Digital promptly upon receipt of an RMA from RF Digital, at Customer's risk and expense; and (3) RF Digital confirms the claimed deficiency is present. If all of these conditions are met, RF Digital, at its sole option, will either replace or repair the RF Device or credit Customer's account for the amount the Customer paid to RF Digital for the RF Device.

End of document.